

50 Ω nominal input / conjugate match balun to nRF51822-QFAAG0 /QFABB0 and nRF51422-QFAAE0 with integrated harmonic filter

Datasheet – production data

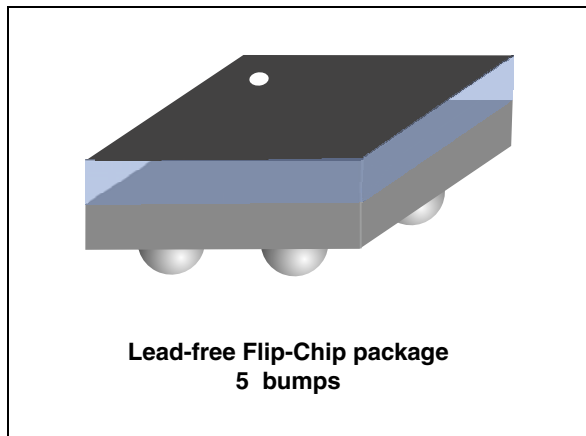

Description

STMicroelectronics BALF-NRF01D3 is an ultraminiature balun. The BALF-NRF01D3 integrates matching network in a monolithic glass substrate. Matching impedance has been customized for the nRF51822-QFAAG0/GC/FA, nRF51822-QFABB0 and nRF51422-QFAAE0 RF transceivers.

The BALF-NRF01D3 uses STMicroelectronics IPD technology on non-conductive glass substrate which optimize RF performances.

Figure 1. Pinout diagram (top view)

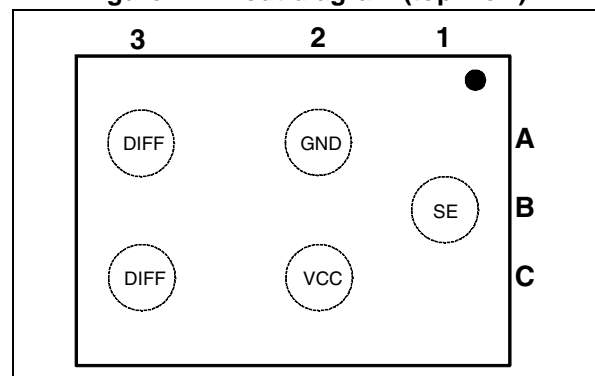

Features

- Low insertion loss
- Low amplitude imbalance
- Low phase imbalance
- Coated Flip-Chip on Glass
- Small footprint: < 1.5 mm²

Benefits

- Very low profile: < 560 μ m after reflow
- High RF performance
- PCB space saving versus discrete solution
- BOM count reduction
- Efficient manufacturability

Applications

- 2.45 GHz balun with integrated matching network
- Matching optimized for following chipsets: nRF51822-QFAAG0/GC/FA, nRF51822-QFABB0 and nRF51422-QFAAE0

1 Characteristics

Table 1. Absolute maximum ratings (limiting values)

Symbol	Parameter	Value			Unit
		Min.	Typ.	Max.	
P _{IN}	Input Power RF _{IN}			20	dBm
V _{ESD}	ESD ratings MIL STD883C (HBM: C = 100 pF, R = 1.5 k Ω , air discharge)	2000			V
	ESD ratings charge device model (JESD22-C101-C)	500			
	ESD ratings machine model (MM: C = 200 pF, R = 25 Ω , L = 500 nH)	500			
T _{OP}	Operating temperature	-40		+85	°C

Table 2. Electrical characteristics(T_{amb} = 25 °C)

Symbol	Parameter	Value			Unit
		Min.	Typ.	Max.	
Z _{OUT}	Nominal differential output impedance		conjugate match to: – nRF51822-QFAAG0/GC/FA – nRF51822-QFABB0 – nRF51422-QFAAE0		Ω
Z _{IN}	Nominal input impedance		50		Ω
F	Frequency range (bandwidth)	2400		2540	
I _L	Insertion loss in bandwidth		1.35	1.46	dB
R _L	Return loss in bandwidth	16.5	17	17.5	dB
φ _{imb}	Phase imbalance	4.5	5	5.5	°
A _{imb}	Amplitude imbalance	0.15	0.2	0.25	dB
2f ₀	2nd harmonic filtering		-15	-14	dB
3f ₀	3rd harmonic filtering		-42	-41	dB

1.1 Simulations results ($T_{amb} = 25\text{ }^{\circ}\text{C}$)

Figure 2. Insertion loss in band

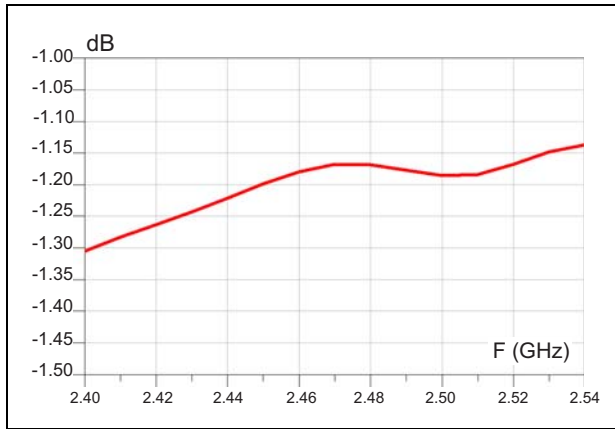

Figure 3. Differential transmission

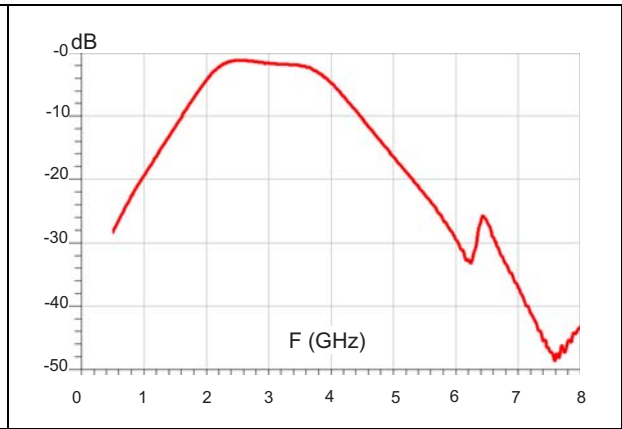

Figure 4. Return loss on SE port

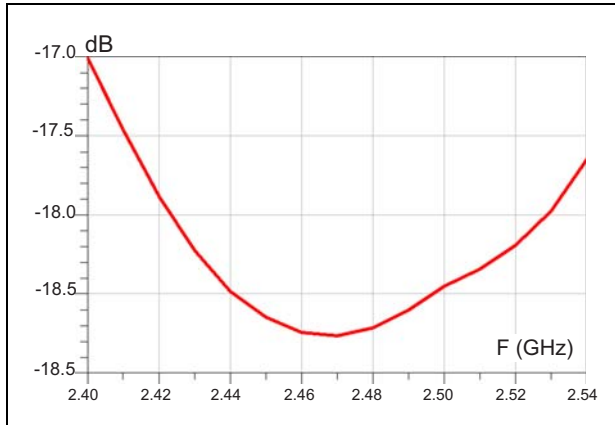

Figure 5. Amplitude imbalance

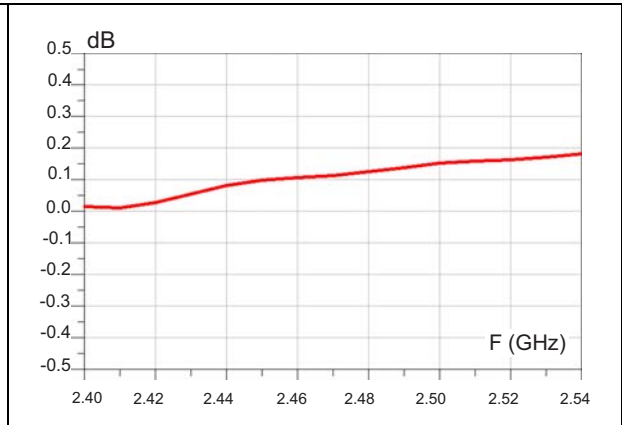

Figure 6. Phase imbalance

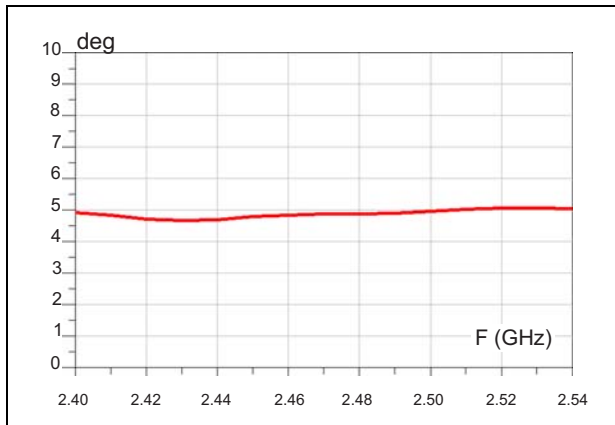

Figure 7. H2 attenuation

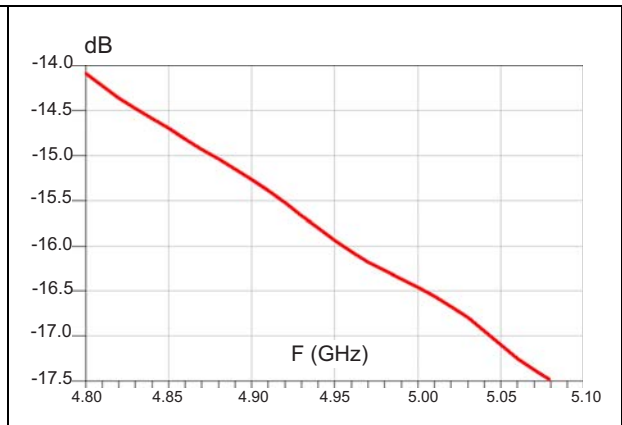
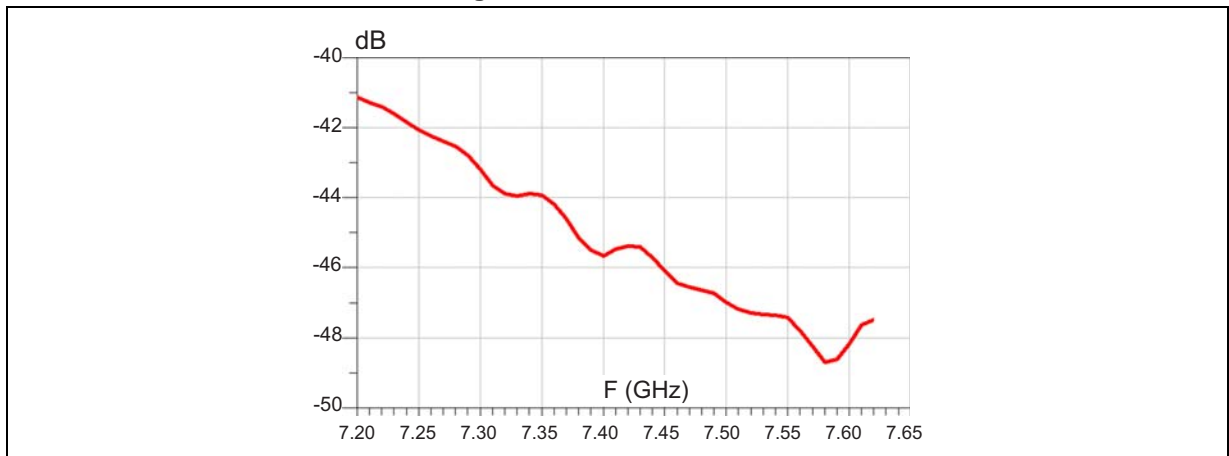
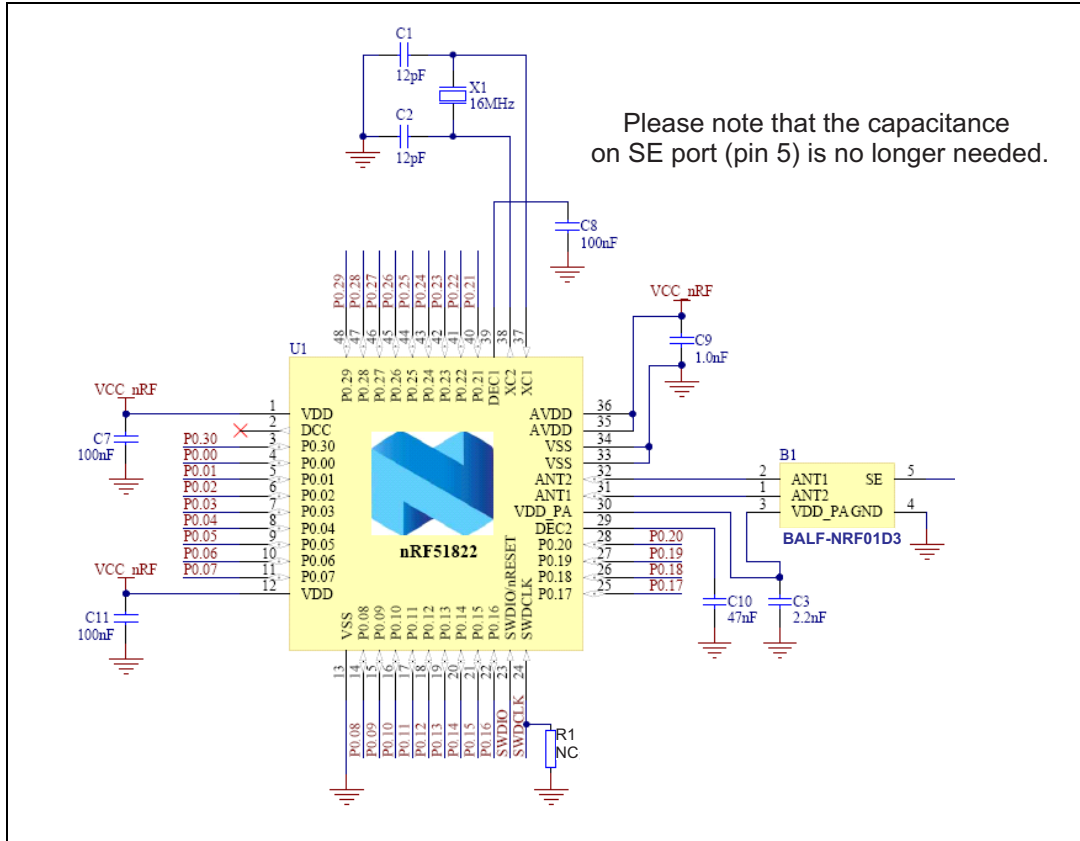

Figure 8. Attenuation in H3



2 Application information

Figure 9. Application schematic



3 Package information

- Epoxy meets UL94, V0
- Lead-free package

In order to meet environmental requirements, ST offers these devices in different grades of ECOPACK® packages, depending on their level of environmental compliance. ECOPACK® specifications, grade definitions and product status are available at: www.st.com. ECOPACK® is an ST trademark.

Figure 10. Package dimensions (top and side view)

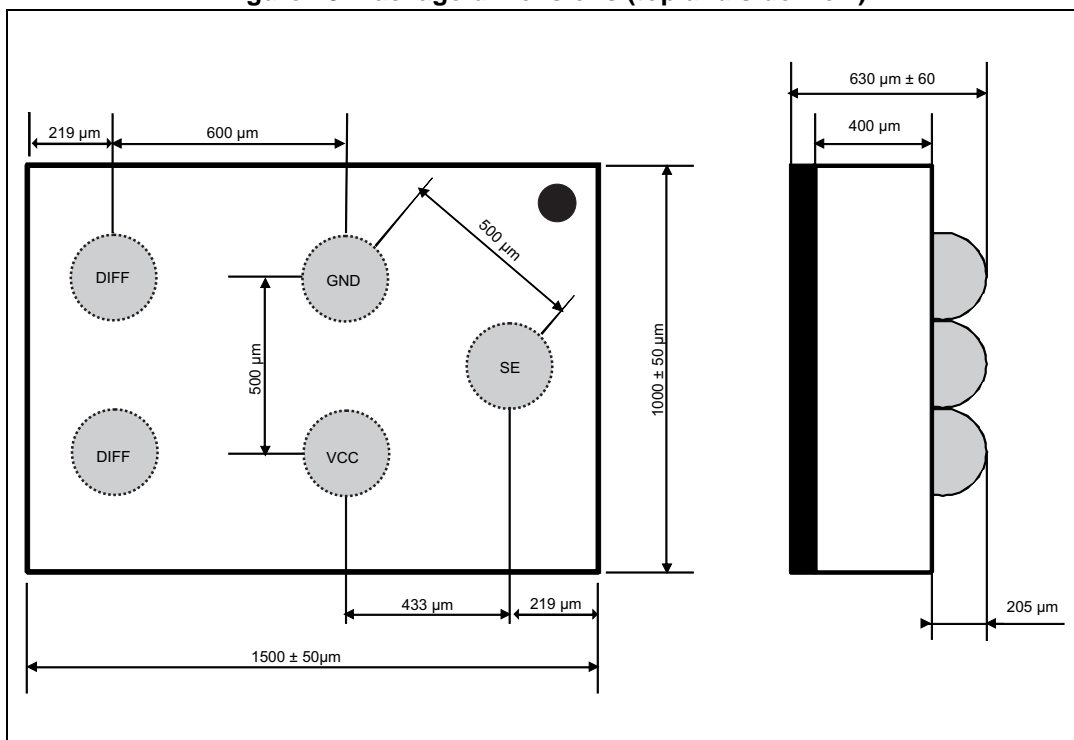

Figure 11. Footprint - non solder mask defined

Figure 12. Footprint - solder mask defined

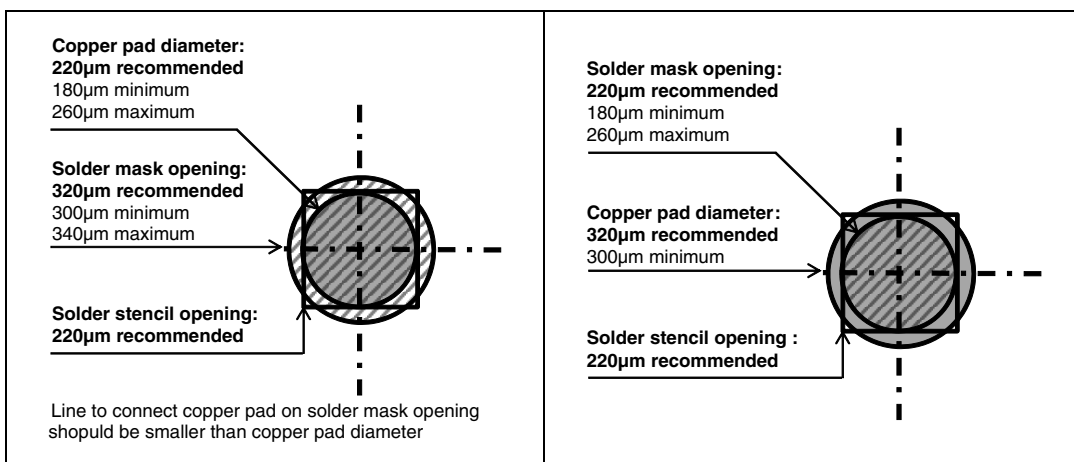

Figure 13. PCB layout recommendation

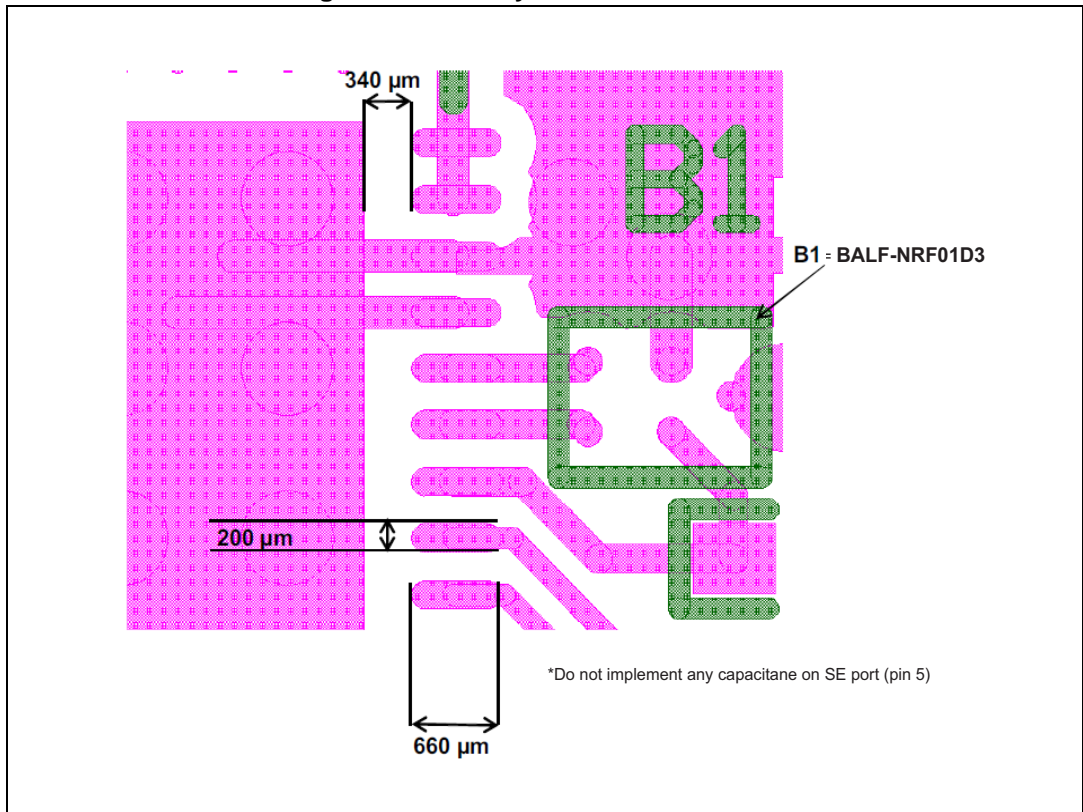

Figure 14. BALF-NRF01D3 position

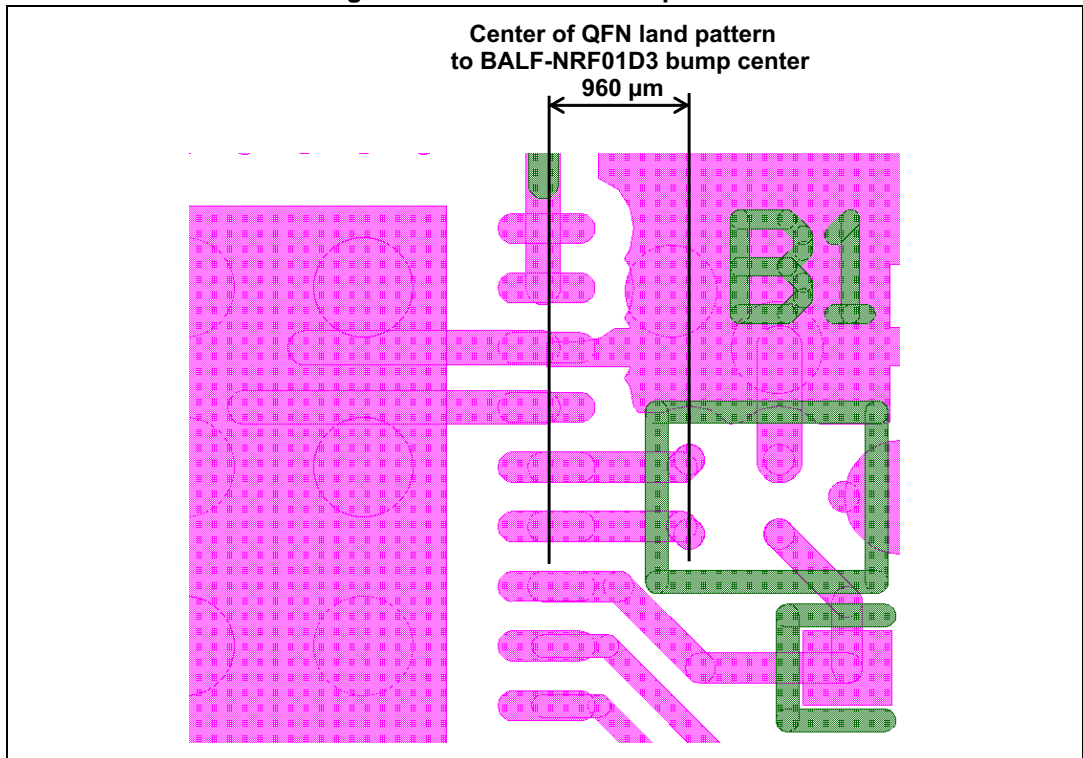

Figure 15. Marking

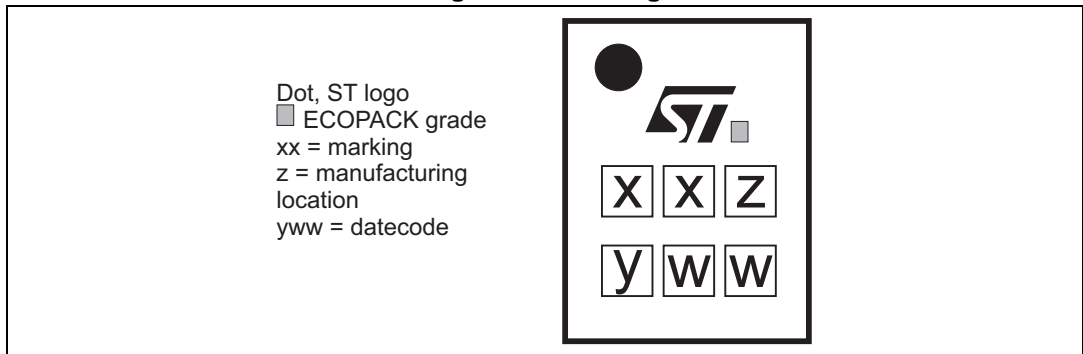
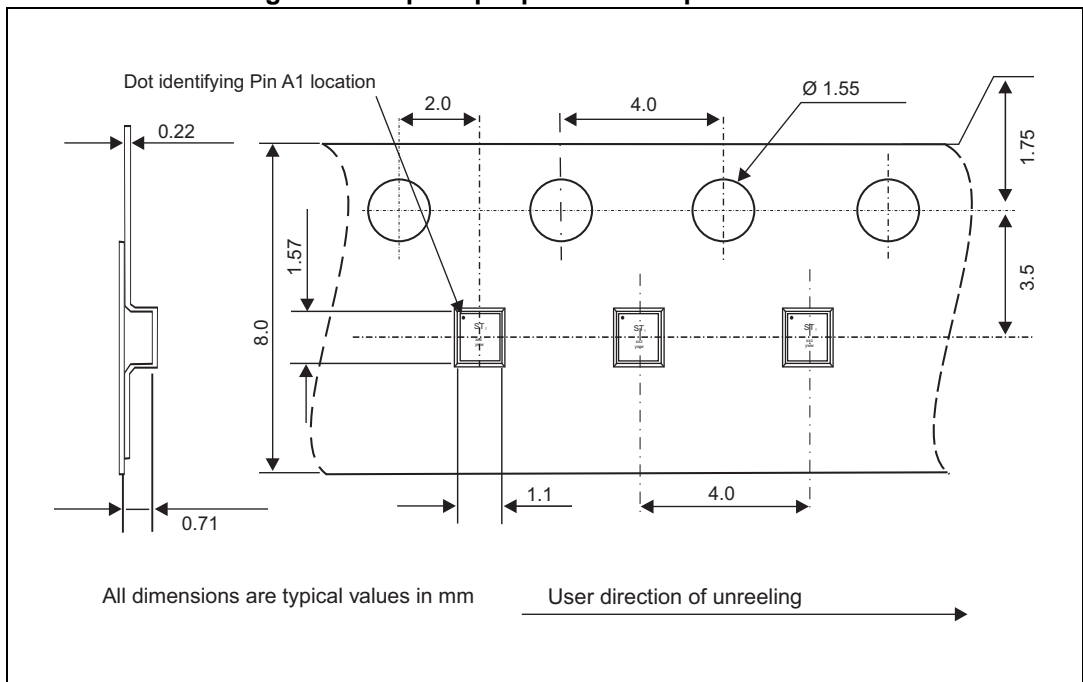

Figure 16. Flip-Chip tape and reel specifications



Note: More information is available in the STMicroelectronics Application note: AN2348 Flip-Chip: “Package description and recommendations for use”

Table 3. Compatibility matrix

Device marking		Balun variant and design files
Packet/variant	Build code	
QFAA	CA	BAL-NRF01D3 + 0.8pF DF-ST V1.0
	C0	BAL-NRF01D3 + 0.8pF DF-ST V1.0
	FA	BALF-NRF01D3 DF-ST V1.x
	GC	BALF-NRF01D3 DF-ST V1.x
	G0	BALF-NRF01D3 DF-ST V1.x
QFAB	AA	BAL-NRF01D3 + 0.8pF DF-ST V1.0
	A0	BAL-NRF01D3 + 0.8pF DF-ST V1.0
	B0	BALF-NRF01D3 DF-ST V1.x

DF-ST = nRF51822 Reference Layout files with STMicroelectronics balun.

Table 4. Compatibility matrix (nRF51422)

Device marking		Balun variant and design files
Packet/variant	Build code	
QFAA	C0	BAL-NRF01D3 + 0.8pF
	CA	BAL-NRF01D3 + 0.8pF
	E0	BALF-NRF01D3
QFAB	A0	BALF-NRF01D3

4 Ordering information

Table 5. Ordering information

Order code	Marking	Weight	Base Qty	Delivery mode
BALF-NRF01D3	ST	1.82 mg	5000	Tape and Reel

5 Revision history

Table 6. Document revision history

Date	Revision	Changes
27-Mar-2014	1	Initial release
04-Jun-2014	2	Updated all curves and added Table 4 .

Please Read Carefully:

Information in this document is provided solely in connection with ST products. STMicroelectronics NV and its subsidiaries ("ST") reserve the right to make changes, corrections, modifications or improvements, to this document, and the products and services described herein at any time, without notice.

All ST products are sold pursuant to ST's terms and conditions of sale.

Purchasers are solely responsible for the choice, selection and use of the ST products and services described herein, and ST assumes no liability whatsoever relating to the choice, selection or use of the ST products and services described herein.

No license, express or implied, by estoppel or otherwise, to any intellectual property rights is granted under this document. If any part of this document refers to any third party products or services it shall not be deemed a license grant by ST for the use of such third party products or services, or any intellectual property contained therein or considered as a warranty covering the use in any manner whatsoever of such third party products or services or any intellectual property contained therein.

UNLESS OTHERWISE SET FORTH IN ST'S TERMS AND CONDITIONS OF SALE ST DISCLAIMS ANY EXPRESS OR IMPLIED WARRANTY WITH RESPECT TO THE USE AND/OR SALE OF ST PRODUCTS INCLUDING WITHOUT LIMITATION IMPLIED WARRANTIES OF MERCHANTABILITY, FITNESS FOR A PARTICULAR PURPOSE (AND THEIR EQUIVALENTS UNDER THE LAWS OF ANY JURISDICTION), OR INFRINGEMENT OF ANY PATENT, COPYRIGHT OR OTHER INTELLECTUAL PROPERTY RIGHT.

ST PRODUCTS ARE NOT DESIGNED OR AUTHORIZED FOR USE IN: (A) SAFETY CRITICAL APPLICATIONS SUCH AS LIFE SUPPORTING, ACTIVE IMPLANTED DEVICES OR SYSTEMS WITH PRODUCT FUNCTIONAL SAFETY REQUIREMENTS; (B) AERONAUTIC APPLICATIONS; (C) AUTOMOTIVE APPLICATIONS OR ENVIRONMENTS, AND/OR (D) AEROSPACE APPLICATIONS OR ENVIRONMENTS. WHERE ST PRODUCTS ARE NOT DESIGNED FOR SUCH USE, THE PURCHASER SHALL USE PRODUCTS AT PURCHASER'S SOLE RISK, EVEN IF ST HAS BEEN INFORMED IN WRITING OF SUCH USAGE, UNLESS A PRODUCT IS EXPRESSLY DESIGNATED BY ST AS BEING INTENDED FOR "AUTOMOTIVE, AUTOMOTIVE SAFETY OR MEDICAL" INDUSTRY DOMAINS ACCORDING TO ST PRODUCT DESIGN SPECIFICATIONS. PRODUCTS FORMALLY ESCC, QML OR JAN QUALIFIED ARE DEEMED SUITABLE FOR USE IN AEROSPACE BY THE CORRESPONDING GOVERNMENTAL AGENCY.

Resale of ST products with provisions different from the statements and/or technical features set forth in this document shall immediately void any warranty granted by ST for the ST product or service described herein and shall not create or extend in any manner whatsoever, any liability of ST.

ST and the ST logo are trademarks or registered trademarks of ST in various countries.

Information in this document supersedes and replaces all information previously supplied.

The ST logo is a registered trademark of STMicroelectronics. All other names are the property of their respective owners.

© 2014 STMicroelectronics - All rights reserved

STMicroelectronics group of companies

Australia - Belgium - Brazil - Canada - China - Czech Republic - Finland - France - Germany - Hong Kong - India - Israel - Italy - Japan - Malaysia - Malta - Morocco - Philippines - Singapore - Spain - Sweden - Switzerland - United Kingdom - United States of America

www.st.com